

SUISEI®



prensatelas industriales

para máquinas de coser | CATALOGO 2013

máquinas de coser, recambios y accesorios

C GRACIA

CONTENTS

SPRING GUIDE FEET	8
TOP STITCH GUIDE FEET	9
QUILTER & GUIDE FOOT	9
SHIRRING FEET	10
COMPENSATING FEET	11 ~ 13
CORDING FEET	14
ZIPPER FEET	14
STANDARD FEET	15
PIPING FEET	16
SPECIAL PIPING FEET	17
TAPE FEET	18
SOLID BLANK FEET	18
SPECIAL TUBE FEET	19
TEFLON FEET	20
NYLON RING FEET	21
HINGED FEET for SPECIAL MACHINE	21
HINGED FEET for NEEDLE FEED MACHINE	22 ~ 23
BINDING FEET	24
HEMMERS	32 ~ 34
SINGLE TURN FELLERS	35

Solicitud de artículos sobrepedido

[la empresa suministra artículos más económicos, de similares características]

Compare List (Old / New)

D : Discontinued

M : Modified

OLD Articles	Description	Rem.	NEW Articles	Page
1-1/2	Hemmer Foot	D	—	—
A1-	Double Fold Bias Binder	M	A1S-	28
A10-	Right Angle Bias Binder	M	A10S-	26
A10-01-3/4	Solid Binding Foot, for A10	D	SA45	24
A10-01-7/8	Solid Binding Foot, for A10	D	SA55	24
A11-	J-type Swing Hemmer	M	A11S-	32
A110-	Full Fold Hemmer	M	A110S-	32
A2-	Single Fold Bias Binder	M	A2S-	29
A32-	Spring Type Lap Seam Folder	D	—	—
A4-	Braid or Tape Binder	M	A4S-	29
A5-	Belt & Loop Folder	M	A5S-	30
A5B-	Straight Folder	M	A5BS-	30
A60-5	Swing Feller	D	—	—
A75D-	Single Downturn Feller	M	A75D-	35
A75U-	Single Upturn Feller	M	A75U-	35
A78	Latch Hemmer	M	A78S-	33
A9-	Plain Bias Binder	M	A9S-	28
AG50	Adjustable Tape Guide	M	AG50S	31
AM2	Regular Cloth Puller	M	AM2Z	45
AP4	Adjustable Cloth Clamp	D	—	—
AP8	Adjustable Cloth Clamp	D	—	—
CB 1	Compen. Binding Foot, for A10	D	SC55	24
CB 1.1/4	Compen. Binding Foot, for A10	D	SC95	24
CB 3/4	Compen. Binding Foot, for A10	D	SC45	24
CD10	Compensating Foot	M	SD10	13
CD15	Compensating Foot	M	SD15	13
CD20	Compensating Foot	M	SD20	13
CF2-S	Nylon Ring Foot	M	SCF2	21
CHN	Compensating Binding Foot	D	SC75	24
CHW	Compensating Binding Foot	D	SC105	24
CL08	Compensating Foot	M	SL10	11
CL08N	Compensating Foot	M	SL10N	11
CL10	Compensating Foot	M	SL10	11
CL15	Compensating Foot	M	SL15	11
CL15N	Compensating Foot	M	SL15N	11
CL20	Compensating Foot	M	SL20	11
CL30	Compensating Foot	M	SL30	11
CR08	Compensating Foot	M	SR10	11
CR08K	Compensating Foot	M	SR10T	12
CR08N	Compensating Foot	M	SR10N	11
CR08NK	Compensating Foot	M	SR10NK	12
CR10	Compensating Foot	M	SR10	11
CR100	Compensating Foot	M	SR100	11
CR15	Compensating Foot	M	SR15	11
CR15K	Compensating Foot	M	SR15T	12
CR15N	Compensating Foot	M	SR15N	11
CR15NK	Compensating Foot	M	SR15NT	12
CR20	Compensating Foot	M	SR20	11
CR25	Compensating Foot	M	SR25	11
CR25K	Compensating Foot	M	SR25T	12
CR30	Compensating Foot	M	SR30	11
CR30K	Compensating Foot	M	SR30K	12
CR40	Compensating Foot	M	SR40	11
CR40K	Compensating Foot	M	—	—
CR50	Compensating Foot	M	SR50	11
CR60	Compensating Foot	M	SR60	11
CR65	Compensating Foot	M	SR65	11
CR70	Compensating Foot	M	SR70	11
CR80	Compensating Foot	M	SR80	11
G20	Magnetic Gauge	M	G20Z	40
G7	Swing Gauge	M	G7E	40
P1	Solid Raising Foot	D	—	—
P127	Hinged Standard Foot	D	SP127	15
P144H	Hinged Foot, Double Toe Even	D	S5050	15
P144HL	Hinged Foot, Turned Up Front	D	S5050V	15
P193	Hinged Standard Foot	D	S6565	15
P27	Hinged Foot, for Needle Feed	D	S5050N	22
P314C	Hinged Tube Foot	D	TU65C	18
P314L	Hinged Tube Foot	D	TU65L	18
P314R	Hinged Tube Foot	D	TU65R	18

OLD Articles	Description	Rem.	NEW Articles	Page
P318C	Hinged Tube Foot	D	TU30C	18
P3316C	Hinged Tube Foot	D	TU50C	18
P3316L	Hinged Tube Foot	D	TU50L	18
P3316R	Hinged Tube Foot	D	TU50R	18
P338C	Hinged Tube Foot	D	TU100C	18
P338L	Hinged Tube Foot	D	TU100L	18
P338R	Hinged Tube Foot	D	TU100R	18
P34	Hemming & Folding Foot	D	SA75	24
P344	Hemming & Folding Foot	D	SA95	24
P351	Hinged Standard Foot	M	SP351	15
P351K	Hinged Standard Foot	M	SP351T	15
P352	Hinged Foot, Turned Up Front	M	SP352	15
P36	Hinged Cording Foot	M	SP36	14
P360	Hinged Foot, Narrow	M	SP360	15
P361	Hinged Foot, Narrow	M	SP361	15
P3610	Hemming & Folding Foot	M	(SA65)	24
P3613	Hemming & Folding Foot	M	(S6060V)	15
P3620	Hemming & Folding Foot	M	(SA105)	24
P3625	Hemming & Folding Foot	M	(SA200)	24
P363	Hinged Zipper Foot	M	S2525	14
P363V	Hinged Zipper Foot	M	S3030	14
P363VNF	Hinged Foot, for Needle Feed	M	S3030N	22
P36L	Hinged Cording Foot	M	SP36L	14
P36LN	Hinged Cording Foot	M	SP36LN	14
P36N	Hinged Cording Foot	M	SP36N	14
P36W	Hinged Cording Foot	D	—	—
P38	Hemming & Folding Foot	D	SA65	24
P386	Hemming & Folding Foot	D	SA55	24
P58N	Hinged Standard Foot	D	SP58N	15
P58W	Hinged Foot, Double Toe Even	D	SG50	15
P69LH-...	Hinged Piping Foot <Left>	M	S69LH-...	16
P69RH-...	Hinged Piping Foot <Right>	M	S69RH-...	16
P810	Hinged Raising Foot	D	SG10	8
P810L	Hinged Raising Foot	D	SG10L	8
P811	Hinged Raising Foot	D	SG15	8
P811L	Hinged Raising Foot	D	SG15L	8
P812	Hinged Raising Foot	D	SG30	8
P812L	Hinged Raising Foot	D	SG30L	8
P813	Hinged Raising Foot	D	SG50	8
P813L	Hinged Raising Foot	D	—	—
P814	Hinged Raising Foot	D	SG65	8
P814L	Hinged Raising Foot	D	—	—
P815	Hinged Raising Foot	D	SG80	8
P815L	Hinged Raising Foot	D	—	—
P946	Hinged Foot, Double Toe Even	M	S4040	15
P953	Adjustable Shirring Foot	M	S955	10
S363NF	Hinged Zipper Foot, for Needle Feed	M	S3030N	22
SH030	Hemmer Foot	D	(A50-3)	33
SH050	Hemmer Foot	D	(A50-5)	33
SH30	Hemmer Foot	D	(A50-3)	33
SH40	Hemmer Foot	D	(A50-4)	33
SH50	Hemmer Foot	D	(A50-5)	33
SH65	Hemmer Foot	D	(A50-7)	33
SHP50	Feller Foot	D	—	—
SP351K	Hinged Standard Foot	M	SP351T	15
SP363	Hinged Zipper Foot	M	S3030	14
SP90-BL	Intermittent Cloth Puller	D	—	—
SP90-FBS	Intermittent Cloth Puller	D	—	—
SP90-RF	Intermittent Cloth Puller	D	—	—
SP90-TR	Intermittent Cloth Puller	D	—	—
SR10K	Compensating Foot	M	SR10T	12
SR15K	Compensating Foot	M	SR15T	12
SR15NK	Compensating Foot	M	SR15NT	12
SR20K	Compensating Foot	M	SR20T	12
T350	Teflon Foot	M	ST350	20
T35CW	Teflon Foot	M	ST35CW	20
T35W	Teflon Foot	M	ST35W	20
T363	Teflon Foot	M	ST363	20
T36LN	Teflon Foot	M	ST36LN	20
T36N	Teflon Foot	M	ST36N	20

* We have no recommendatory articles or substitution for old articles concerning the items are specified "—" on NEW Articles column.

NEW PRODUCTS

NOUVEAUX PRODUITS
PRODUCTOS NUEVOS

NEUE PRODUKTE

Attachments

SUISEI®



SFG1 Finger Guard Set for One Needle Lock Stitch Machine

For One Needle



- After setting finger guard to presser bar, it keeps working for finger protection.

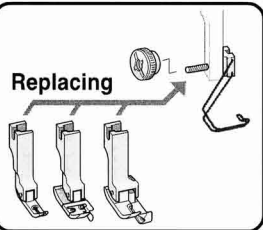

Replacing

SFG1

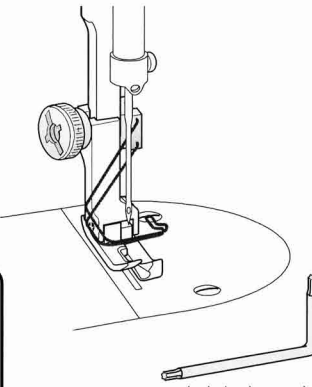

Includes L-wrench.

"SFG-D20" Torx® driver is available at extra cost.

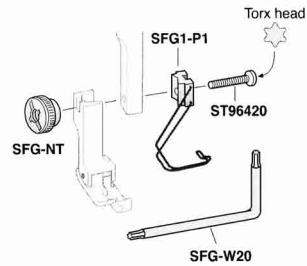

Part Number	Description
SFG1-P1	Guard Wire Complete
ST96420	Screw with Torx Head
SFG-NT	Thumb Nut
SFG-W20	L-Wrench for Torx Head
SFG-D20	Driver for Torx Head

Torx® is registered by Textron Fastening Systems (Camcar Screw & Mfg.)

SFG1NW Finger Guard Set Without L-Wrench for One Needle Lock Stitch Machine

For One Needle



- After setting finger guard to presser bar, it keeps working for finger protection.

SFG1NW

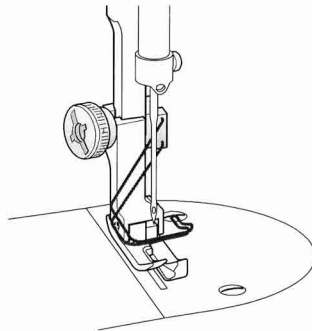

Torx® is registered by Textron Fastening Systems (Camcar Screw & Mfg.)

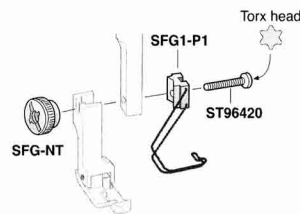

Part Number	Description
SFG1-P1	Guard Wire Complete
ST96420	Screw with Torx Head
SFG-NT	Thumb Nut

You can not use following articles in our products together with SFG1.

A10S-40, A10S-45, A10S-50, A10H-, P723, P723NF

When using SFG1 for needle feed machine, the maximum stitch length is 4 millimeters.

SFG1 is not able to attached to few kinds of machine which has a special presser bar.

NEW PRODUCTS

NOUVEAUX PRODUITS
PRODUCTOS NUEVOS

NEUE PRODUKTE

Attachments

SUISEI®



SRC10~SRC30, SLC10~SLC30 Compensating Feet <Extra Short>

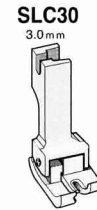
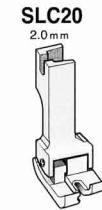
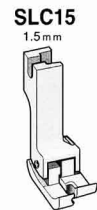
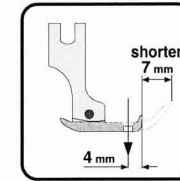
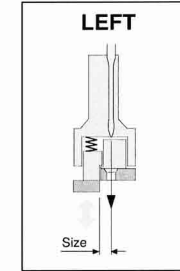
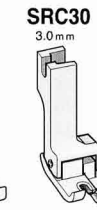
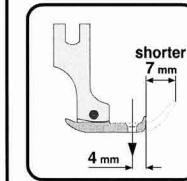
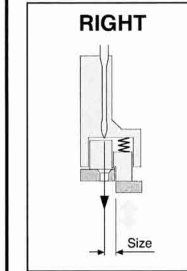

- These feet are appropriate for sewing small parts as out pockets or labels. Because it is 4 millimeters long the toe side from the needle and 7 millimeters shorter than regular compensating feet.

SR10NF~SR30NF, SL10NF~SL30NF Compensating Feet For Needle Feed Machine

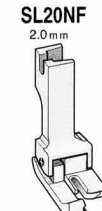
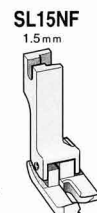
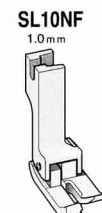
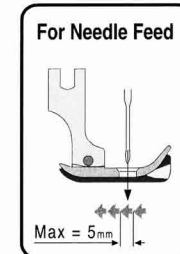
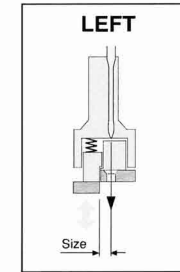
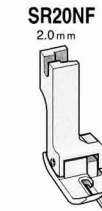
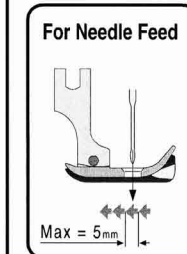
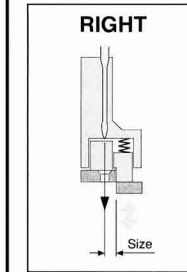

- Not use for plain sewing machine, will cause "Skip stitch". Because these are for needle feed machine.

NEW PRODUCTS

NOUVEAUX PRODUITS
PRODUCTOS NUEVOS

NEUE PRODUKTE

Attachments

SUISEI®



SG70, 110, 150, 200 Spring Guide Hinged Feet

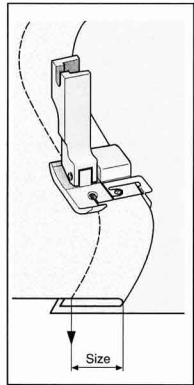

SG70
7.0 mm

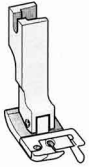

SG110
11.0 mm

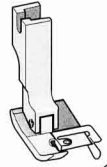

SG150
15.0 mm

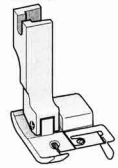

SG200
20.0 mm

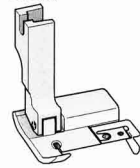

Screw & Spring Guides

SG-P0 For all Feet		M1.6 x 0.35
SG-P1 For SG10~SG30 SG110L, SG150, SG200		Stainless steel
SG-P2 For SG50~SG80		Stainless steel
SG-P1L For SG10L~SG30L		Stainless steel

ST·NF Teflon Feet for Needle Feed

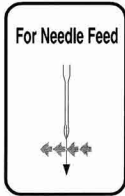

ST350NF

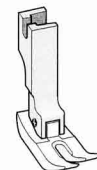

5.5 mm ↓ 5.5 mm

ST35WNF



6.5 mm ↓ 6.5 mm

ST350NFB



for "ST350NF"

ST35WNFB



for "ST35WNF"

P723NF Hinged Quilter Foot with Right & Left Guides for Needle Feed

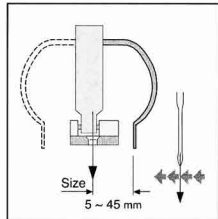

Size
5 ~ 45 mm

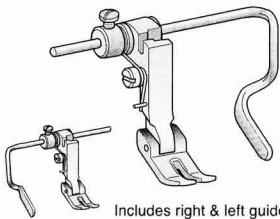

Includes right & left guides.

SCF2 Nylon Ring Foot

Double Rings

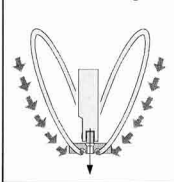

SCF2

8 mm ↓ 8 mm

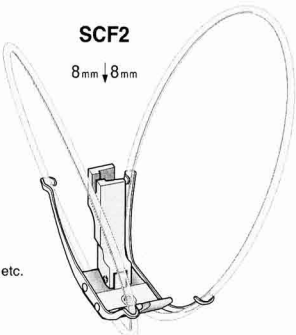

- Appropriate for slippery and problem materials, like Velvet, Plastic-coated, Rubber-backed, etc.

SCF1L Left Nylon Ring Foot

Single Ring

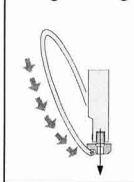

SCF1L

6.5 mm ↓ 4.5 mm

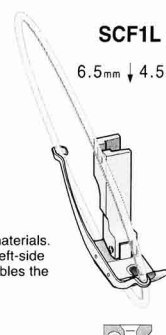

- Appropriate for slippery materials. Especially single ring on left-side and narrow foot shoe enables the sewing of the small bag.

SPRING GUIDE FEET

PIEDS AVEC RESSORT GUIDE
PIES PRENSATELA CON GUÍA

KANTENFEDER-FÜSSE

Attachments

SUISEI®



SG10~SG80 Spring Guide Hinged Feet

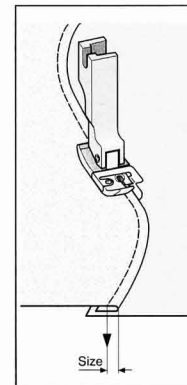

SG10
1.0 mm

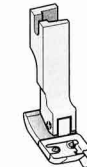

SG15
1.5 mm

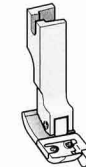

SG20
2.0 mm

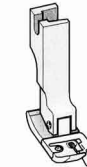

SG30
3.0 mm

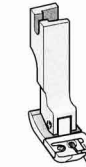

SG10L
1.0 mm



SG15L
1.5 mm

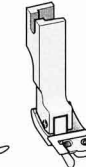

SG50
5.0 mm

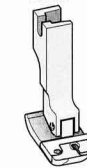

SG65
6.5 mm

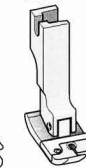

SG70
7.0 mm

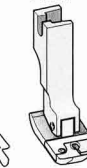

SG80
8.0 mm

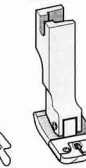

SG20L
2.0 mm

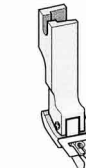

SG30L
3.0 mm

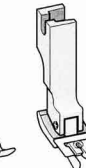

- For straight and curving edges. NO guide part at the rear of the needle hole.

SG110, SG150, SG200 Spring Guide Hinged Feet

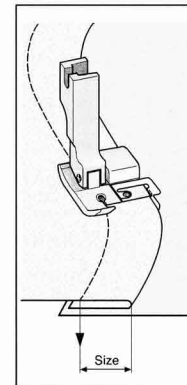

SG110
11.0 mm

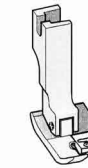

SG150
15.0 mm

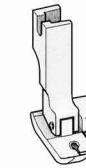

SG200
20.0 mm

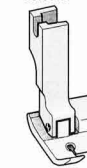

SG-P1

SG-P1

SG-P1

Screw & Spring Guides

SG-P0 For all Feet		M1.6 x 0.35
SG-P1 For SG10~SG30 For SG80~SG200		Stainless steel
SG-P2 For SG50~SG80		Stainless steel
SG-P1L For SG10L~SG30L		Stainless steel

SPRING GUIDE FEET

PIEDS AVEC RESSORT GUIDE
PIES PRENSATELA CON GUÍA

KANTENFEDER-FÜSSE

Attachments

SUISEI®



P10~P18 Top Stitch Guide Feet

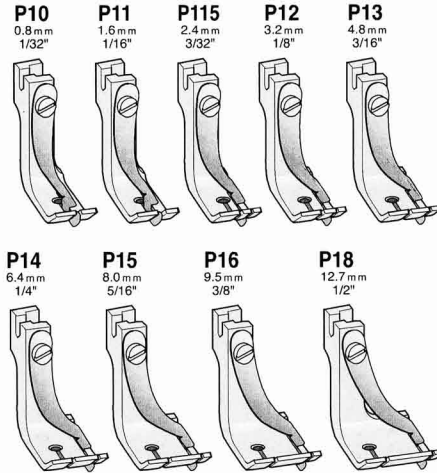
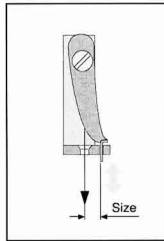

Screw & Spring Guides

3352 For all Feet	
P01 For P10~P13	
P01W For P14~P18	

- The lower material can be hurt by the spring guide when it is weak and thin. Then **SG series feet** on P.9 are recommended.

SHIRRING FEET

PIEDS FRONCEURS
PIES PRENSATELA DE FRUNCIDO

KRÄUSELFÜSSE

Attachments

SUISEI®



P5 Top Ply Joining Shirring Foot

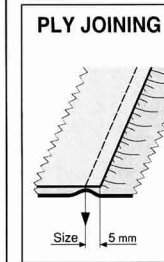

P50, P50M, P50H Regular Shirring Feet

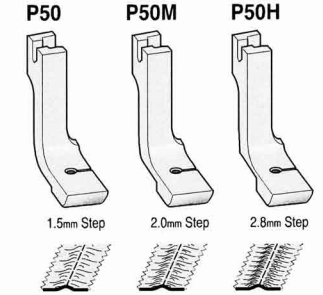
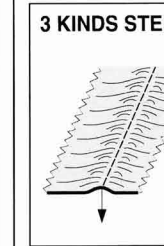

S955 Adjustable Shirring Foot

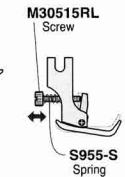
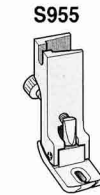
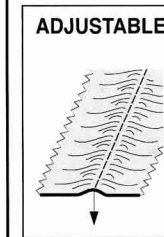

- For bottom ply of pocket flap lining.

Be careful

- Over turning of the adjust screw causes damage of the pin.
- Feeding scratches can happen when the material is weak and thin.

QUILTER & GUIDE FOOT

PIEDS ARTICULÉS AVEC GUIDE
PIES PRENSATELA CON GUÍA AJUSTABLE

GELENKFÜSSE MIT LINEAL(EN)

Attachments

SUISEI®



P723 Hinged Quilter Foot with Right & Left Guides

RIGHT & LEFT

NF

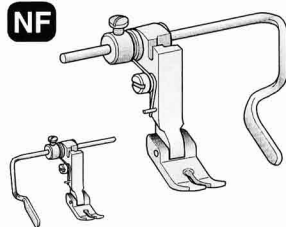
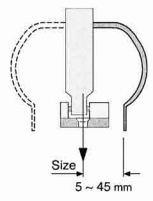

Includes right & left guides.

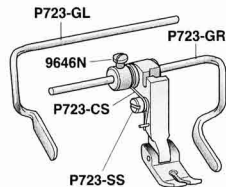

Part Number	Description
P723-GL	Left Guide
P723-GR	Right Guide
9646N	Screw (9/64-L6)
P723-SS	Shoulder Screw
P723-CS	Spring

GUIDE FEET FOR HEMMERS

PIEDS AVEC GUIDE POUR OURLEUR
PIES DE GUÍA PARA REPULUGADORES

GELENKFÜSSE MIT LINEAL FÜR SÄUMAPPARATE

Attachments

SUISEI®



P3811, P3819, P3825 Guide Feet for Hemmers

For FOLDERS

with Left Edge Guide

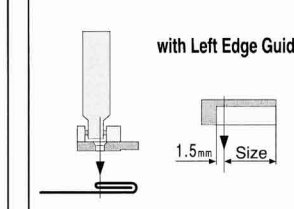

P3811



P3819



P3825

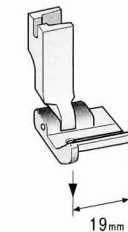

COMPENSATING FEET

Attachments

SUISEI®

PIEDS COMPENSÉS
PIES PRENSATELA COMPENSANDOS

AUSGLEICHS-GELENKFÜSSE

SR10(N)~CR130 Compensating Foot <Right>

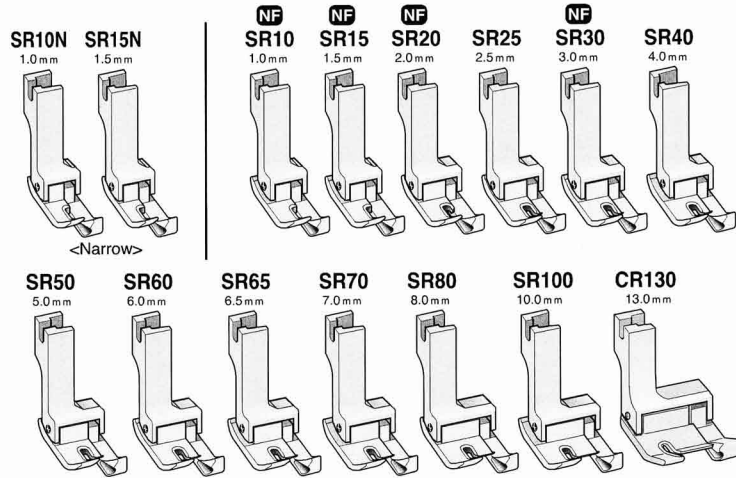
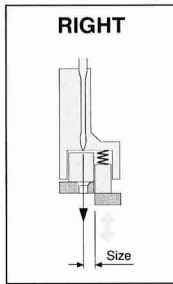

SL10(N)~CL130 Compensating Foot <Left>

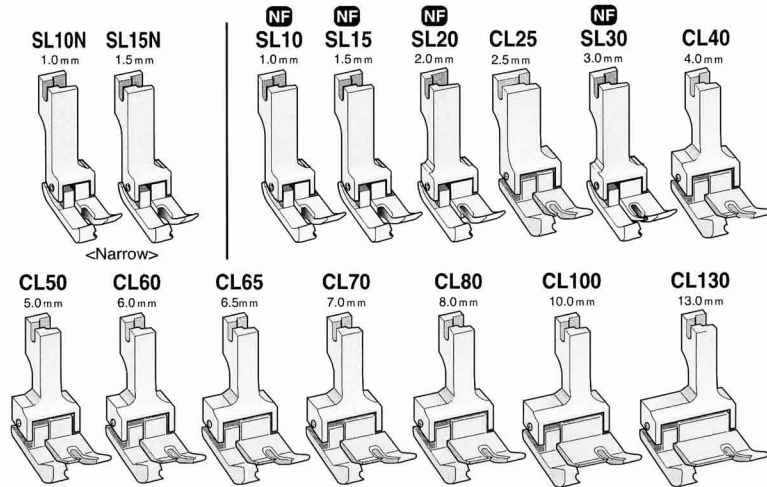
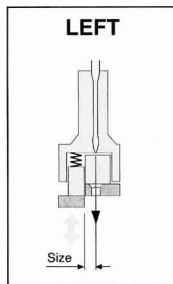

- The replacement screw and spring for [SR..., SL...] type are different from [CR..., CL...] type's, please refer next page.
- Guide shoe has two springs B20 and **foot shoe has one** for [SR..., SL...] type feet.
- It may get good result for some kind of the sewing that the spring B20 on **foot shoe** is removed.

COMPENSATING FEET

Attachments

SUISEI®

PIEDS COMPENSÉS
PIES PRENSATELA COMPENSANDOS

AUSGLEICHS-GELENKFÜSSE

SR10(N)K~CR130K Compensating Feet for Knit <Right>

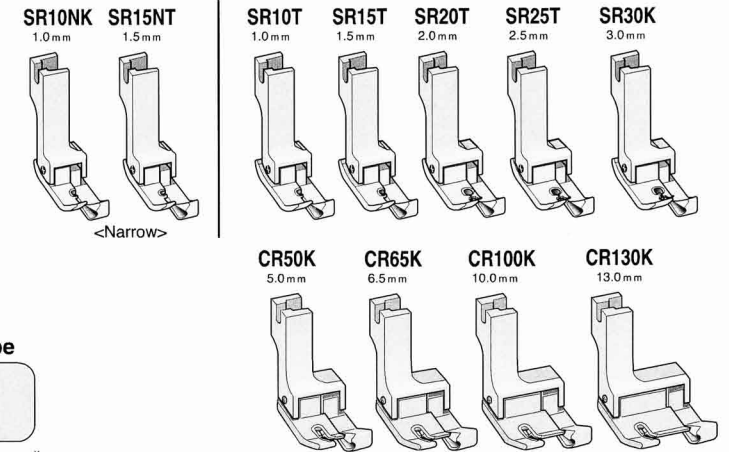
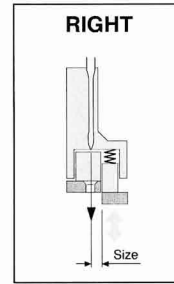

• For knit & thin materials.

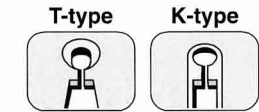

Prevents lifting fabric with the needle.

SRC10~SRC30, SLC10~SLC30 Compensating Foot <Extra Short>

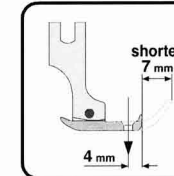
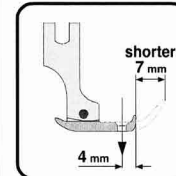
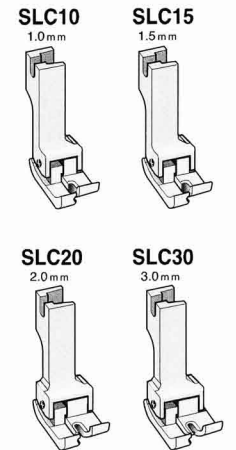
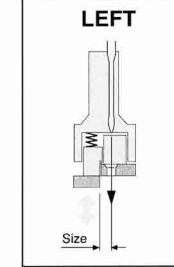
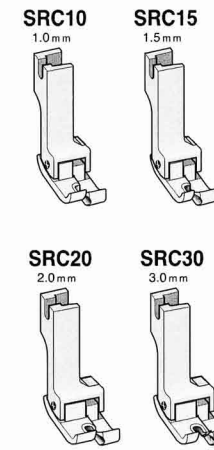
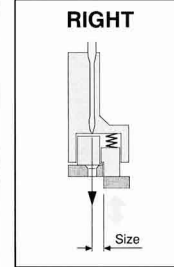

- These feet are appropriate for sewing small parts as out pockets or labels. Because it is 4 millimeters long the toe side from the needle and 7 millimeters shorter than regular compensating feet.

COMPENSATING FEET

PIEDS COMPENSÉS
PIES PRENSATELA COMPENSANDOS

AUSGLEICH-GELENKFÜSSE

Attachments

SUISEI®



SD10~SD30 Compensating Feet <Double>

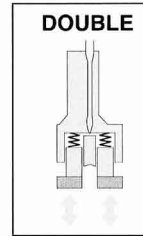

SD10
1.0mm

SD15
1.5mm

SD20
2.0mm

SD30
3.0mm

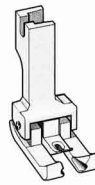
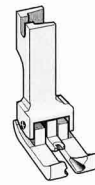
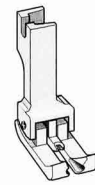
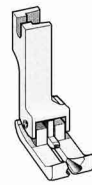

Inches to Millimeters

Inches	MM	Recommended Numbers
1/32	→ 0.8	→ 10
1/16	→ 1.6	→ 15
3/32	→ 2.4	→ 25
1/8	→ 3.2	→ 30
5/32	→ 4.0	→ 40
3/16	→ 4.8	→ 50
1/4	→ 6.4	→ 65
5/16	→ 8.0	→ 80
3/8	→ 9.5	→ 100
1/2	→ 12.7	→ 130

For SR, SL, SD type

B20, CPS10~CPS19 Replacement spring and screws for "SR, SL, SRC, SLC, SD"

B20 ø2.0 mm All Feet for "SR, SL, SRC, SLC, SD" & "SR·NF, SL·NF" type

CPS10 10.8 .. 10(N)(NF), 15(N)(NF), SD10, S955
SC40~105, SHA30~80

CPS13 13.3 .. 20(NF), 25, 30(NF), 40
SD15, SD20

CPS16 16.3 .. 50, 60, 65, 70
SD30

CPS19 19.3 .. 80, 100

For CR, CL, CD type

B25, C1~C8 Replacement spring and screws for "CR, CL, CD"

B25 ø2.5 mm All Feet for "CR, CL, CD" type

C1 10.0 .. 08N(K), 10N(K), 15N(K)
P952, P953

C02 12.5 .. CD00

C2 13.5 .. 08, 10, 15, 20, 25, 30
CD10, CHN, CHW, CB

C3 14.5 .. CD15

C4 15.5 mm 40, 50, CD20

C5 17.5 .. 60, 65, 70

C6 19.0 .. 80

C7 20.5 .. 100

C8 24.0 .. 130

CORDING FEET

PIEDS A COUDRE AU BORD
PIES PRENSATELA PARA COSER CREMALLERAS

KANTENFÜSSE

Attachments

SUISEI®



SP36L(N) Hinged Cording Feet <Left>

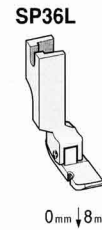
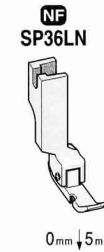
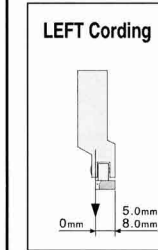

0mm ↓ 5mm

0mm ↓ 8mm

SP36(N) Hinged Cording Feet <Right>

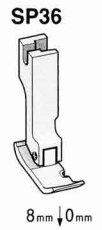
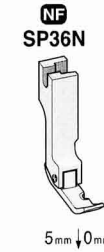
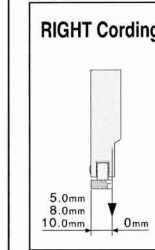

5mm ↓ 0mm

8mm ↓ 0mm

P301(N) Solid Cording Feet <Left>

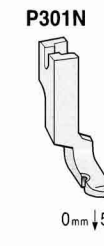
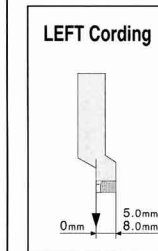

0mm ↓ 5mm

0mm ↓ 8mm

P311N,P31,P311 Solid Cording Feet <Right>

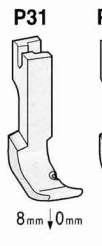
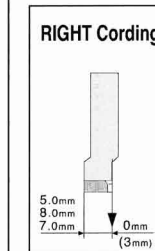

5mm ↓ 0mm

8mm ↓ 0mm

7mm ↓ 0mm
(3mm)

ZIPPER FEET

PIEDS POUR FERMETURE A GLISSIERE
PIES PRENSATELA PARA CREMALLERAS

REISSVERSCHLUSSFÜSSE

Attachments

SUISEI®



S2525, S3030 Hinged Zipper Feet

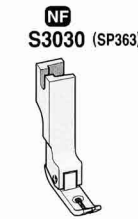
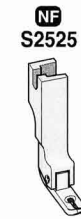
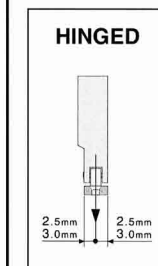

2.5mm ↓ 2.5mm

3mm ↓ 3mm

P3, P3C, P3CS Solid Zipper Feet

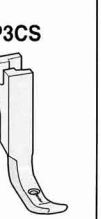
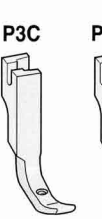
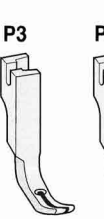
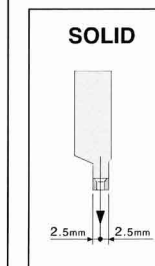

2.5mm ↓ 2.5mm

2.5mm ↓ 2.5mm

2.5mm ↓ 2.5mm

Split

Hole in Center

Closed Split

STANDARD FEET

PIEDS STANDARD
PIES PRENSATELA NORMALIZADAS

STANDARD NÄHFÜSSE

Attachments

SUISEI®



SP58N, SP351(T), S6565, SP127 Hinged Standard Feet

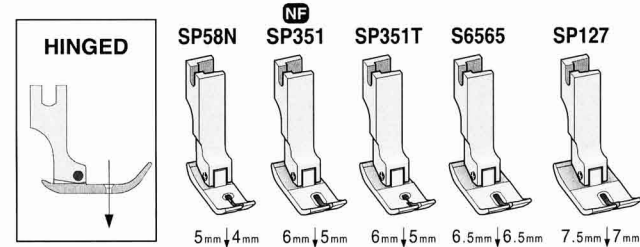

P983 Solid Half Foot

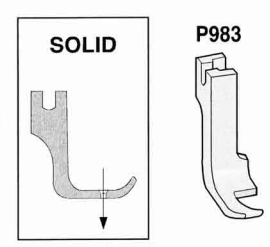

S4040, S5050 Hinged Feet <Double Toe Even>

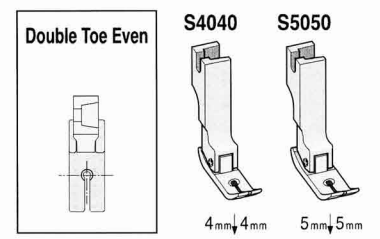

S4040V, S5050V, S6060V, SP352 Hinged Feet <Turned Up Front>

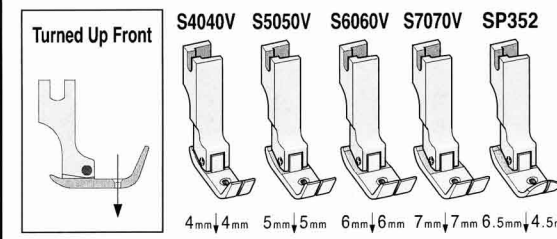

S1060, S1560, SP360 Hinged Feet <Left Narrow>

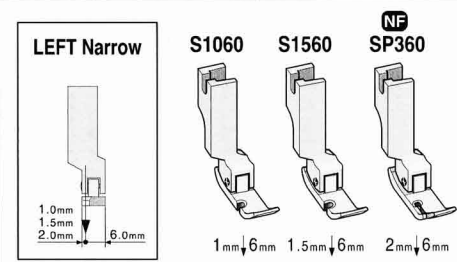

S6010, S6015, SP361 Hinged Feet <Right Narrow>

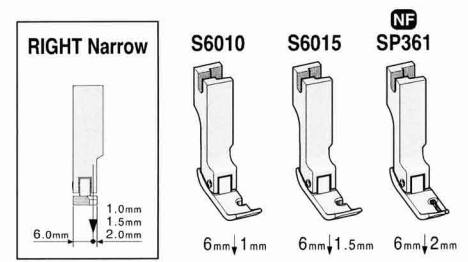

B20, CPS07 Spring and Screw for Hinged Feet

自由押え金用一バネ・ネジ

B20



ø2.0 mm

• All compensating presser feet [SR..., SL...] type, hinged feet [S...] and teflon feet [ST...] type have this spring.

CPS07



L=7.5 mm

• All compensating presser feet [SR..., SL...] type, hinged feet [S...] and teflon feet [ST...] type have this screw.

PIPING FEET

PIEDS POUR POSE DE CORDONNET
PIES PRENSATELA PARA COSER VIVOS DE CORDÓN

KORDELFÜSSE

Attachments

SUISEI®



S69LH- 30,50,65 Hinged Piping Feet <Left>

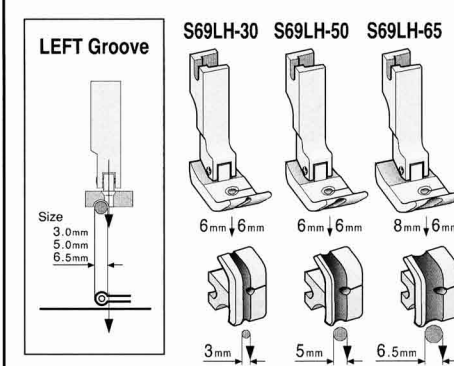

S69RH- 30,50,65 Hinged Piping Feet <Right>

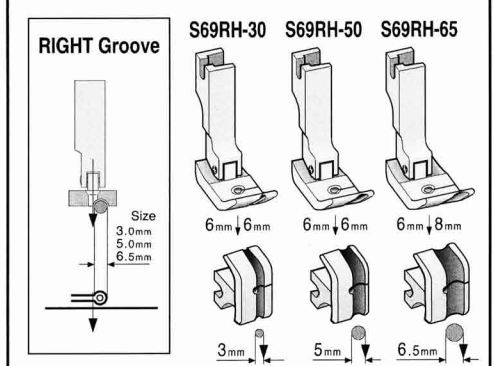

P69L-... , P69R-... , P69D-... Solid Piping Feet <Left> <Right> <Double>

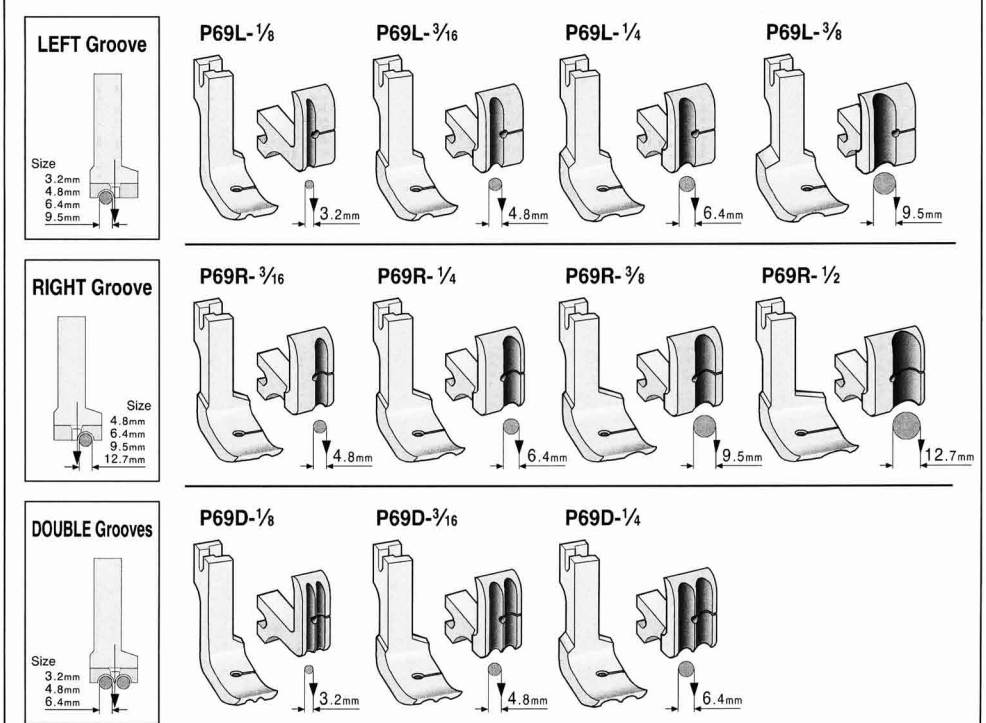

SPECIAL PIPING FEET

Attachments

SUISEI®

PIEDS SPECIAL POUR POSE CORDONNET
PIES PRENSATELA ESPECIAL PARA COSER VIVOS DE CORDÓN

SPEZIAL-KORDELFÜSSE

P31C-... Special Piping Feet <Left>

LEFT Groove

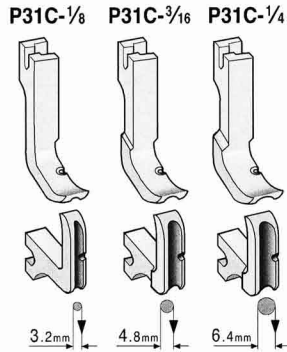
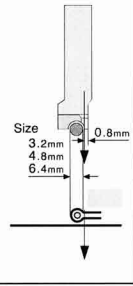

- These feet are appropriate to sewing when there are some obstacles (ex. zipper) or when a side roller is installed at **right side**.

P301C-... Special Piping Feet <Right>

RIGHT Groove

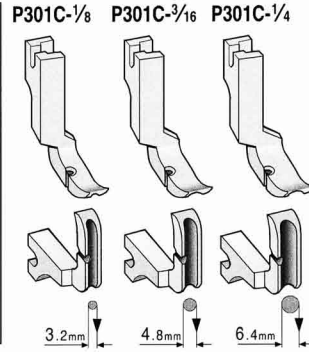
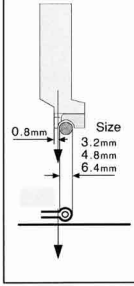

- These feet are appropriate to sewing when there are some obstacles (ex. zipper) or when a side roller is installed at **left side**.

BIAS PIPING FEET

Attachments

SUISEI®

PIEDS POUR POSE DE BIAIS
PIES PRENSATELA PARA ADORNAR CON CORDÓN

SCHRÄGBAND-KORDELFÜSSE

A20- 14-32 Bias Cord Piping Foot

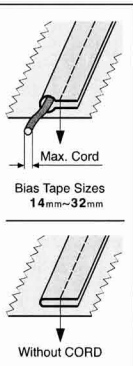

A20-14-32

Bias Tape Sizes	Max. Cord
14 mm	2.5 mm
16 "	
18 "	
20 "	
22 "	3.0 mm
24 "	
26 "	
28 "	
32 "	3.5 mm
32 "	

- Regular set is fixed P37. If not appropriate to the finish, please change to P37M or P37W feet are also available at extra cost.

P37, P37M, P37W Special Piping Feet for "A20"

for "A20"

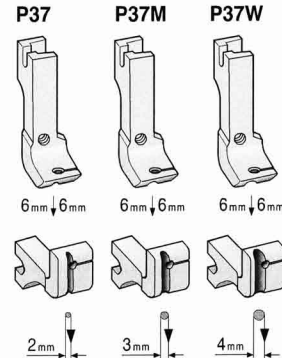
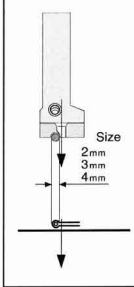

TAPE FEET

Attachments

SUISEI®

PIEDS ARTICULÉS POSE BANDE
PIES PRENSATELA DE TUBO

GELENK-BANDAUFNÄHFÜSSE

TU30C~100C, TU50L~100L, TU50R~100R Hinged Tape Feet <Center> <Left> <Right>

CENTER Tape

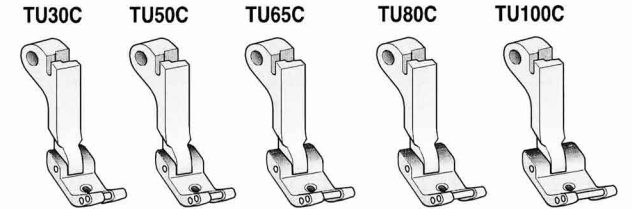
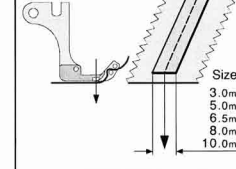

LEFT Tape

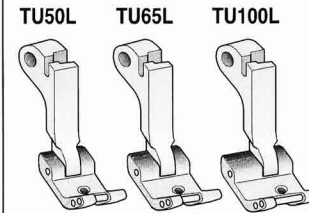
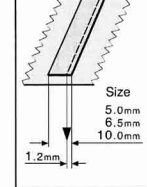

RIGHT Tape

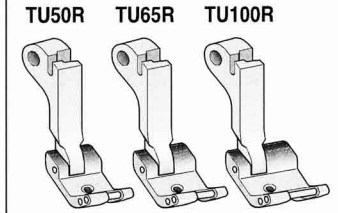
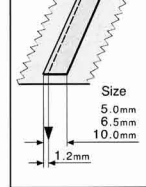

- Foot shoes are precisely grooved to needle position, and it enables to stabilize sewing tape on at curving and corner.

SOLID BLANK FEET

Attachments

SUISEI®

PIEDS A SEMELLE BRUTE
PIES PRENSATELA DE PLANTILLA BRUTA

ROHLINGE

SP60, SP61, SP62, SP63, SP64, SP65 Solid Blank Feet

BLANK

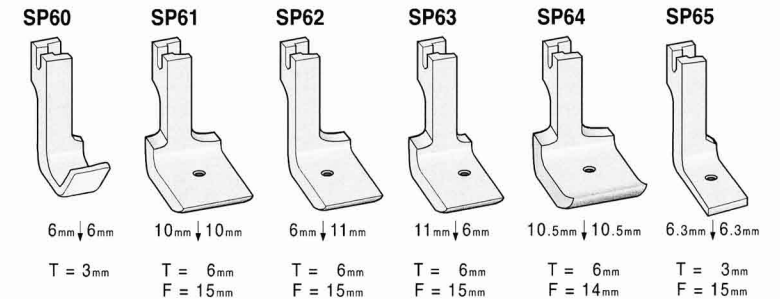
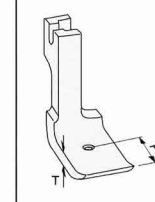

- These feet are not hardened, and can be easily cut away as you like.

SPECIAL TUBE FEET

Attachments

SUISEI®

PIEDS SPECIAL POUR POSE CORDONNET
PIES PRENSATELA ESPECIAL PARA COSER VIVOS DE CORDÓN

SPEZIAL-BANDAUFNÄHFÜSSE

A18 Adjustable Tape Foot <30mm>

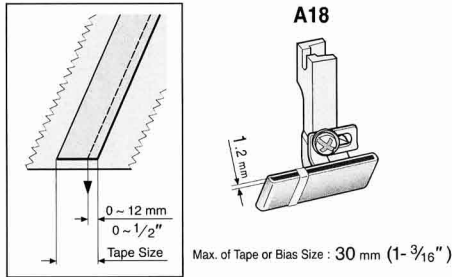

A255 Adjustable Tape Foot <55mm>

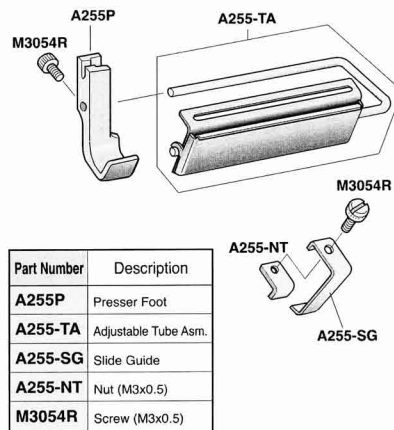
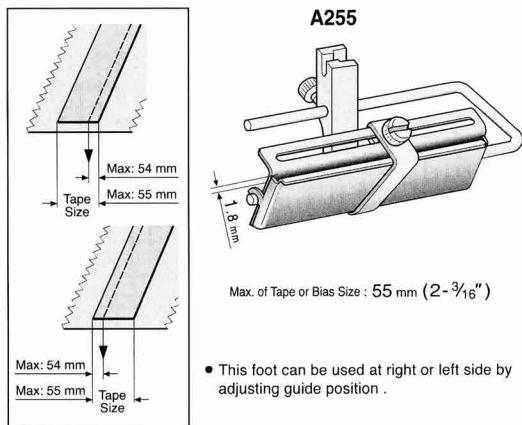

A21- 3~6.5 Bias Loop Piping Foot

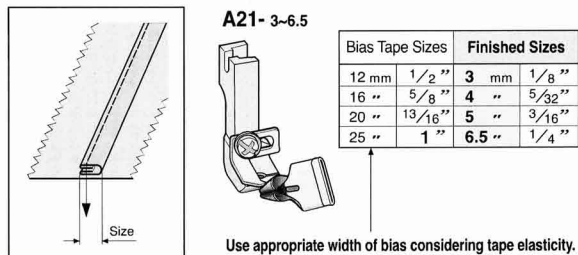

Foot and Parts for "A18" or "A21"

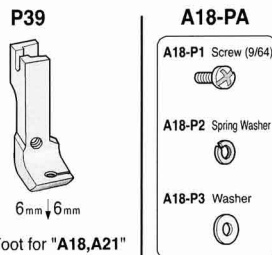

TEFLON FEET

Attachments

SUISEI®

PIEDS TEFLON
PIES PRENSATELA DE TEFLON

TEFLON-NÄHFÜSSE

ST350 Teflon Foot <Regular>



ST35W Teflon Foot <Double Toe Even>



ST35CW Teflon Foot <Hole In Center>

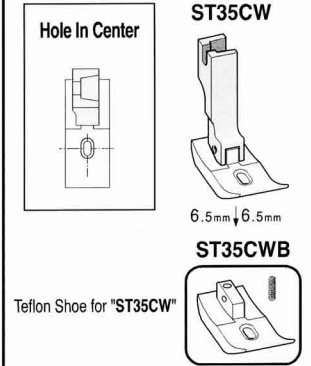

ST363 Teflon Zipper Foot



ST36LN Teflon Cording Foot <Left>



ST36N Teflon Cording Foot <Right>

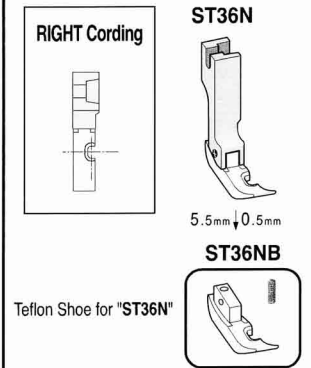

B20, CPS07 Spring and Screw for Teflon Feet

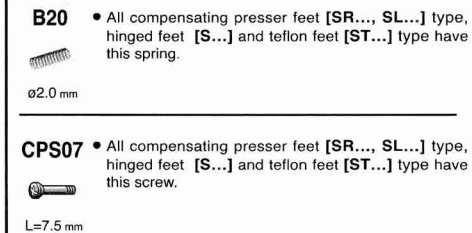

B30U, C06, C07, C1 Spring and Screws for Old Type

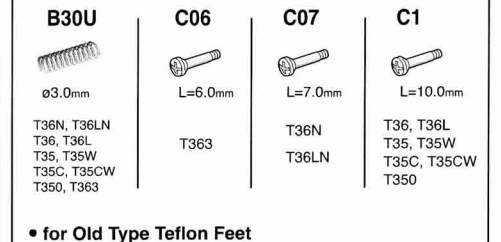

NYLON RING FOOT

PIEDS A ANNEAU NYLON
PIES PRENSATELA CON ANILLOS DE NYLÓN

FÜSSE MIT NYLONRINGEN

Attachments

SUISEI®



SCF2 Nylon Ring Foot



Double Rings

- Appropriate for slippery and problem materials, like Velvet, Plastic-coated, Rubber-backed, etc.

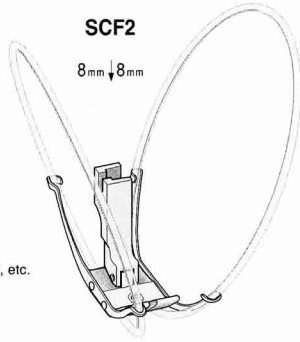

SCF2

8mm ↓ 8mm

SCF1L Left Nylon Ring Foot

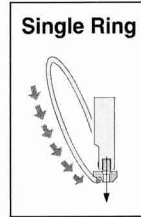

Single Ring

- Appropriate for slippery materials. Especially single ring on left-side and narrow foot shoe enables the sewing of the small bag.

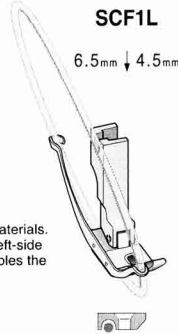

SCF1L

6.5mm ↓ 4.5mm

CFR-S Replacement Nylon Rings for "CF2-S"

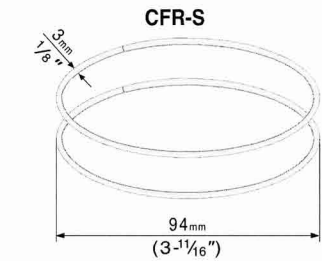

CFR-S

- Please change a couple of the rings when replacing.

HINGED FEET for SPECIAL MACHINE

PIEDS ARTICULÉS POUR SPECIAL MACHINES
PIES PRENSATELA DE BISAGRA PARA ESPECIAL MÁQUINAS

GELENKFÜSSE FÜR SPEZIAL NÄHMASCHINEN

Attachments

SUISEI®



P375, P375B, P375BL Hinged Feet for Zig-Zag Machine

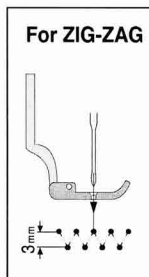

For ZIG-ZAG

5mm ↓ 5mm



P375

5mm ↓ 5mm

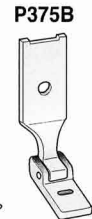

P375B

5mm ↓ 5mm

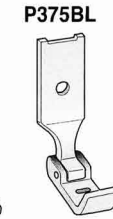

P375BL

Blank / Turned Up Front

P882 Hinged Foot for 111W, 211W Needle Feed Machine

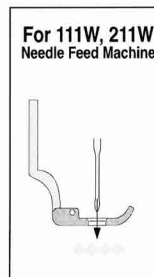

For 111W, 211W
Needle Feed Machine

P882

7mm ↓ 6mm

FEET for NEEDLE FEED MACHINE

PIEDS POUR ENTRÎNEMENT PAR AIGUILLE
PIES PRENSATELA PARA ARRASTRE POR AGUJA

FÜSSE FÜR NADELTRANSPORT

Attachments

SUISEI®



SR10NF~SR30NF, SL10NF~SL30NF Compensating Feet For Needle Feed Machine

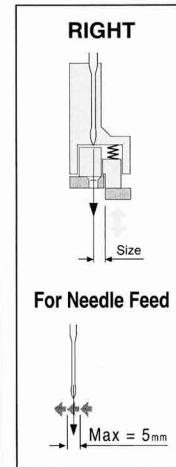

RIGHT

For Needle Feed

Max = 5mm

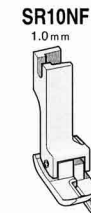

SR10NF
1.0mm



SR15NF
1.5mm



SR20NF
2.0mm

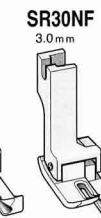

SR30NF
3.0mm

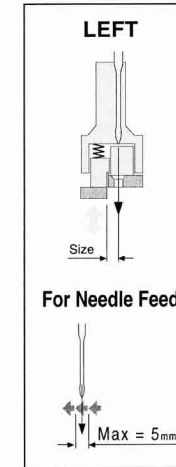

LEFT

For Needle Feed

Max = 5mm

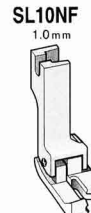

SL10NF
1.0mm

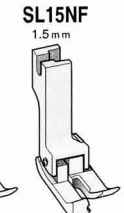

SL15NF
1.5mm



SL20NF
2.0mm

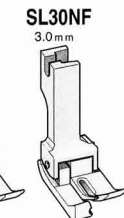

SL30NF
3.0mm

S...N, S351NF Hinged Feet for Needle Feed Machine (One Needle)

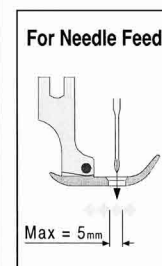

For Needle Feed

Max = 5mm

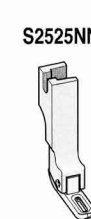

S2525NN

2.5mm ↓ 2.5mm
No Split

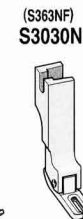

(S363NF)
S3030N

3mm ↓ 3mm



(P27)
S5050N

5mm ↓ 5mm

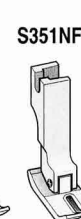

S351NF

6mm ↓ 5mm

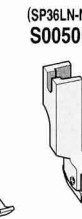

(SP36LN-NF)
S0050N

0mm ↓ 5mm

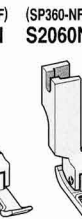

(SP360-NF)
S2060N

2mm ↓ 6mm



(SP36N-NF)
S5000N

5mm ↓ 0mm



(SP361-NF)
S6020N

6mm ↓ 2mm

P723NF Hinged Quilter Foot with Right & Left Guides for Needle Feed

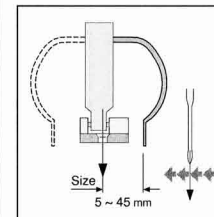

Size
5 ~ 45mm

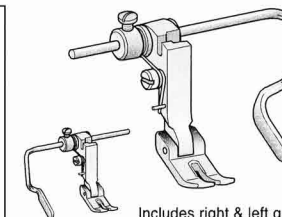

Includes right & left guides.

Be careful

- Not use for plain sewing machine, will cause "Skip stitch". Because these are for needle feed machine.

FEET for NEEDLE FEED MACHINE

PIEDS POUR ENTRÎNEMENT PAR AIGUILLE FÜSSE FÜR NADELTRANSPORT
PIES PRENSATELA PARA ARRASTRE POR AGUJA

Attachments

SUISEI®



ST350NF Teflon Foot <Regular> for Needle Feed

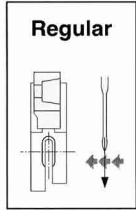

ST350NF

Teflon Shoe for "ST350NF"

ST350NFB



5.5mm ↓ 5.5mm

ST35WNF Teflon Foot <Double Toe Even> for Needle Feed

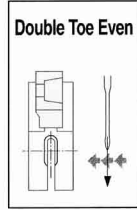

ST35WNF

Teflon Shoe for "ST35WNF"

ST35WNFB



6.5mm ↓ 6.5mm

P112B-..., P112J-1/4 Hinged Brassiere Feet, Two Needle Compensating Foot for Jeans

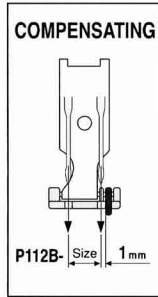

P112B- Size 1mm

• For brassiere, shirts or thin materials.

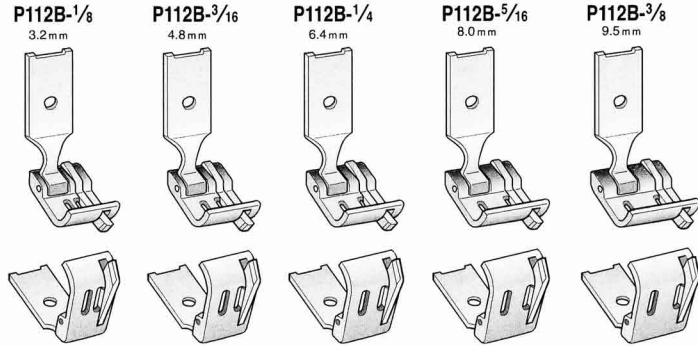

For HEAVY Mat.

P112J- Size 2mm

• For jeans or heavy materials.

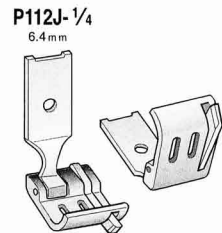

BINDING FEET

PIEDS POUR BORDEURES ET OURLEUR FÜSSE FÜR EINFASSEN UND SÄUMER
PIES PRENSATELA PARA RIBETEAADORES

Attachments

SUISEI®



SA40~SA250 Hinged Binding Feet

SA40 SA45 SA55 SA65 SA75 SA85 SA95 SA105 SA130 SA150 SA200 SA250

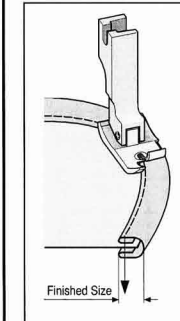
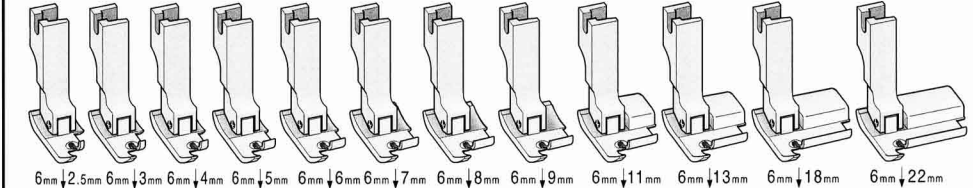

SA...	A10S Bias Tape Sizes	A1S Bias Tape Sizes	A2S Bias Tape Sizes	A4S Tape Sizes	A9S Bias Tape Sizes	A5S Finished Sizes	A5BS Finished Sizes	A11S (A110S) Hem Sizes
SA40	16	20	20	10	-	-	-	-
SA45	18, 20	22	22	-	-	-	-	-
SA55	22, 24	24, 26	24	13	25	5	-	6 mm
SA65	26, 28	28, 30	-	-	28	-	-	-
SA75	30, 32	32	-	16	32	8	8	8 mm
SA85	-	36	-	-	-	-	-	-
SA95	36	40	-	19	-	10	10	10 mm
SA105	40	-	-	22, 25	38	12	12	-
SA130	45	-	-	-	-	-	-	13 mm
SA150	50	-	-	-	-	15, 18	15, 18	15, 18 mm
SA200	-	-	-	-	-	20, 24	20, 24	20 mm
SA250	-	-	-	-	-	30, 40	-	25 mm ~

You can locate the folder near needle position and sew easily curving edge.

SC40~SC105 Compensating Binding Feet

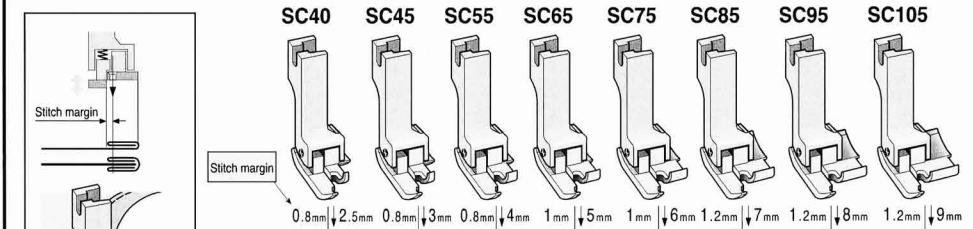

SC...	A10C Bias Tape Sizes	A1S Bias Tape Sizes	A2S Bias Tape Sizes	A4S Tape Sizes	A9S Bias Tape Sizes	A5S Finished Sizes	A5BS Finished Sizes	A11S (A110S) Hem Sizes
SC40	16	20	20	10	-	-	-	-
SC45	18, 20	22	22	-	-	-	-	-
SC55	22, 24	24, 26	24	13	25	5	-	6 mm
SC65	26, 28	28, 30	-	-	28	-	-	-
SC75	30, 32	32	-	16	32	8	8	8 mm
SC85	-	36	-	-	-	-	-	-
SC95	36	40	-	19	-	10	10	10 mm
SC105	40, 45, 50	-	-	22, 25	38	12 ~	12 ~	13 mm ~

These feet keep much stabler stitch margin because left guide shoe holds edge of binding or hemming.

• The contents in above table may be different from fact because of material thickness or elasticity of tape.

HEMMERS

OURLEURS
REPULGADORES

SÄUMER

Attachments

SUISEI®



SINGLE TURN FELLERS

RABATTEURS
DOBLADILLADORES

KAPPNAHTAPPARATE

Attachments

SUISEI®



H6010- 1/16~1/4 Ball Hemmer Feet

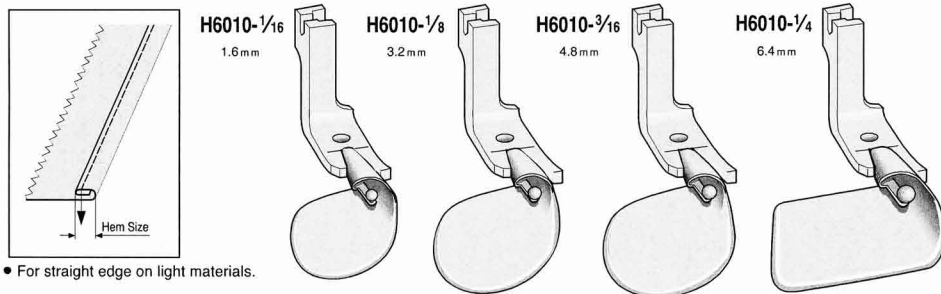

SH80, 095 Hemmer Feet

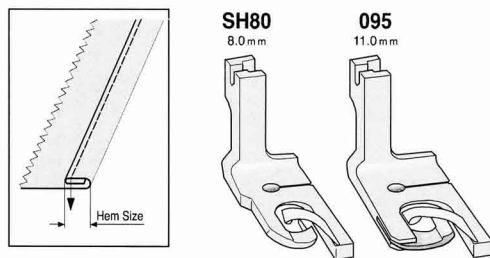

H5018- 3/16 Spring Wire Hemmer Foot

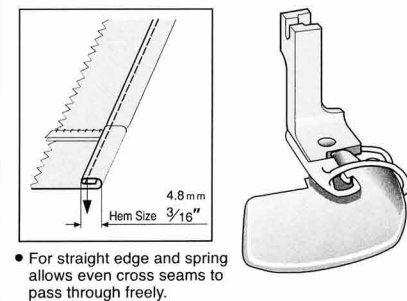

H5017, H5019, H5019R, H5020 Top Stitch Feller Feet

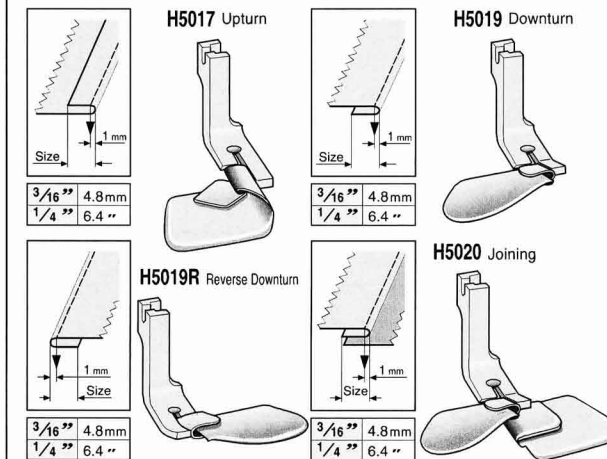

SHP30, SHP65, P75, P9 Feller Feet

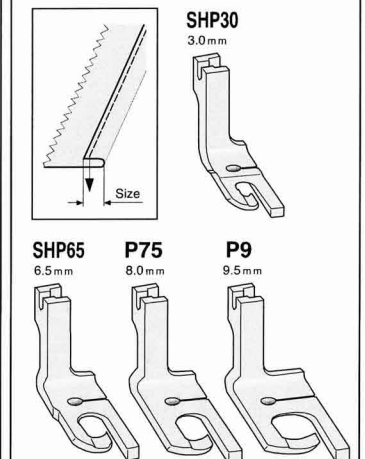

HINGED FOOT FOR TAPE

Gelenkfuß für Nähen von Gummizügen / Prensatelas normal para cinta o cinta de goma

S29CH-30

3.0mm



S29CH-45

4.5mm

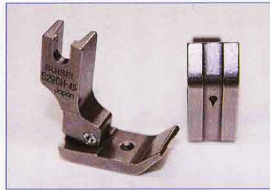

S29CH-55

5.5mm



PROCESSABLE ALP FOOT FOR BINDER

Nähfuß für Einfasser und ALP-Bearbeitung / Prensatelas ALP procesable para ribeteadora

STPA65

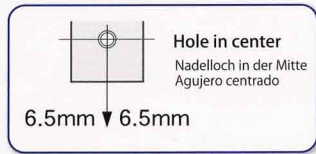

ALP material can be easily cut by cutter.

Leichtes Zuschneiden von ALP-Material mit Schneideinrichtung.
Se puede cortar fácilmente el material ALP con cúter.

※ **Shoe only STPA65B**

Nur Schuhe
Sólo para zapatos

Currently available in only one size.
Other sizes may be added upon request.

Zurzeit nur in einer Größe erhältlich.
Je nach Bedarf soll der Angebotsumfang erweitert werden.

Actualmente está disponible sólo 1 tamaño.
Se ampliará la gama de tamaños según pedidos.

A50 SWING HEMMER

A50 Rollsäumer / A50 Aparato dobladillador aletilla



For curve edge on thin or medium materials.

Für die runden Kanten von dünnen oder mitteldicken Materialien.
Adecuado para costura de curvas en telas finas o medianas.

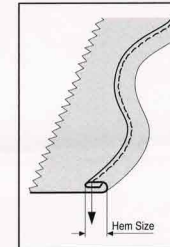

Hem Size	Presser Feet
2.5 mm	SHA25Z
3 "	SHA30Z
4 "	SHA40
5 "	SHA50
6 "	SHA60
7 "	SHA70
8 "	SHA80
10 "	SHC95

Ideal for curved lines.

Besonders geeignet für abgerundete Kanten.
Ideal para curva.

PRESSER FEET SHA Series

Nähfuß SHA - Modellreihe / Prensatelas serie SHA

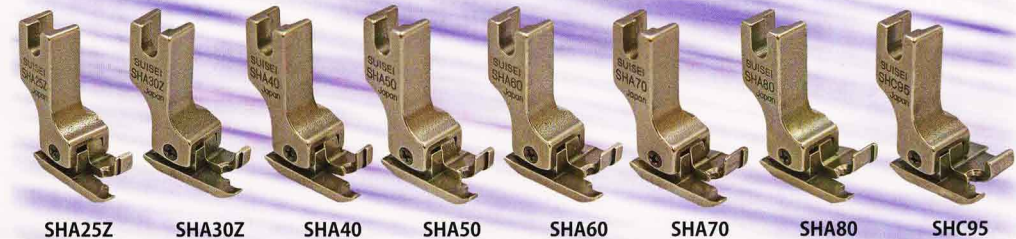

Point

It is very difficult to hem with hemmer foot. This hemmer set is designed to resolve the difficulty and enables operators as even beginners to be skillful hemming.

Das Arbeiten mit herkömmlichem Säumerfuß ist schwierig und erfordert hohe Qualifikation. Daher ist diese Kombination aus Säumer und Nähfuß so ausgelegt, dass damit sowohl erfahrene Kräfte als auch Neulinge problemlos arbeiten können.

La operación con pie dobladillador convencional da ciertas dificultades. Con este conjunto de embudo y prensatelas diseñado para solucionarlas, incluso los operadores novatos pueden trabajar con toda seguridad.

SPRING GUIDE HINGED FEET

Gelenkfuß mit Federführung / Prensateles normal con guía de resorte

The SG Series makes sewing easy!

SG-Modellreihe für noch einfacheres Nähen! / Con la serie SG es más cómoda la costura.

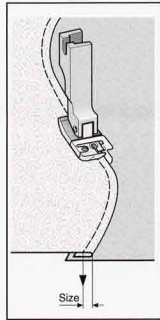

For straight and curving edges.
Für gerade oder runde Kanten.
Adecuado a la costura de recta y curva.

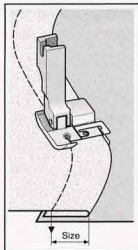
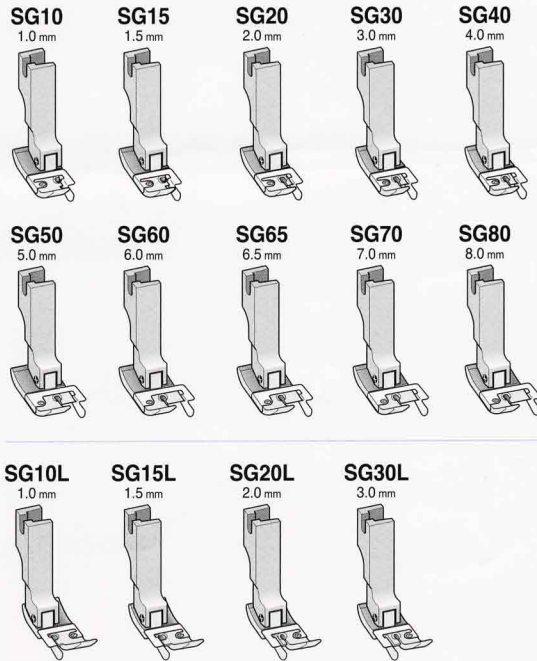

SPRING GUIDE HINGED FEET FOR NEEDLE FEED MACHINE

Gelenkfuß mit Federführung für Nadeltransportmaschine
Prensateles normal con guía de resorte para máquinas de alimentación por aguja

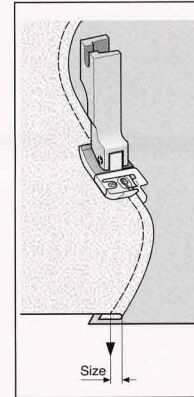

For straight and curving edges.
Für gerade oder runde Kanten.
Adecuado a la costura de recta y curva.

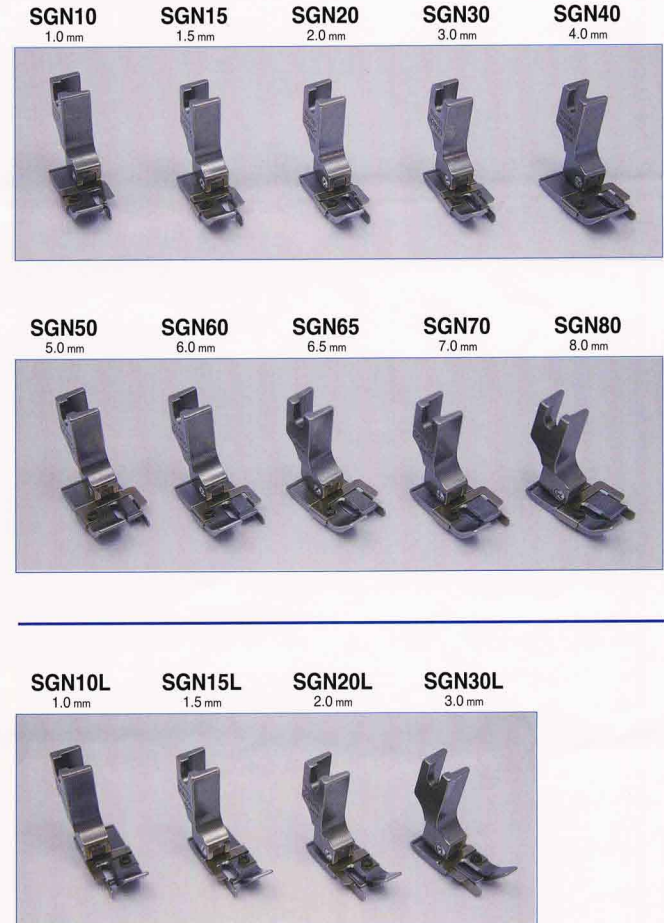

FOR NEEDLE FEED MACHINE

Für Nadeltransportmaschine / Para máquinas de alimentación por aguja

Compensating Feet for Needle Feed Machine

Ausgleichsgelenkfuß für Nadeltransportmaschine
Prensateles de compensación para máquinas de alimentación por aguja

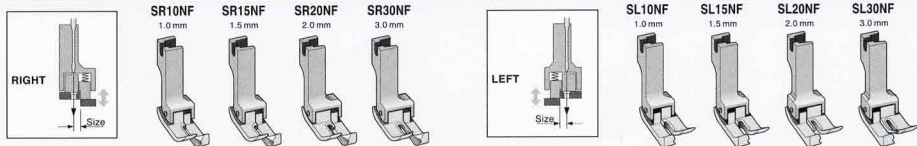

Hinged Feet for Needle Feed Machine(One Needle)

Gelenkfuß für Nadeltransportmaschine
prensateles normal para máquinas de alimentación por aguja

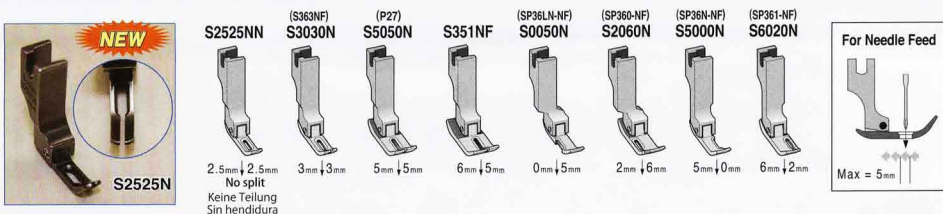

Hinged Binding Feet for Needle Feed Machine

Einfasser-Gelenkfuß für Nadeltransportmaschine
Prensateles normal para ribeteadora para máquinas de alimentación por aguja

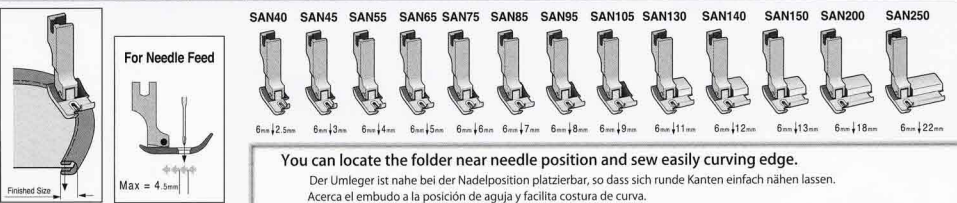

ALP Feet for Needle Feed Machine

ALP Nähfuß für Nadeltransportmaschine
prensateles ALP para máquinas de alimentación por aguja



Hinged Quilter Foot with Right & Left Guides for Needle Feed

Gelenk-Steppfuß mit linker und rechter Führung für Nadeltransport
Prensateles de acolchado con guías derecha e izquierda para máquinas de alimentación por aguja



These feet are for needle feed machine. Do not use them on single needle lockstitch machine, it will cause "Skip stitch".

Diese Nähfüße sind für Nadeltransportmaschinen bestimmt. Sie dürfen keinesfalls in Einnadel-Steppstichmaschinen eingesetzt werden, da sonst die Gefahr von „Fehlstichen“ droht.

Estos prensateles son aplicables a la máquinas de alimentación por aguja. No se deben montar en las otras máquinas de coser, lo que puede causar falta de puntadas.